

## Digital Transistors (Built-in Resistors)

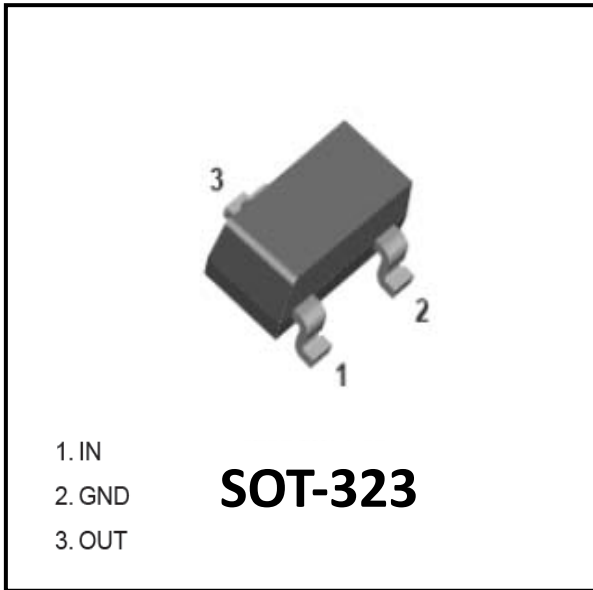

### Features

- Epoxy meets UL-94 V-0 flammability rating
- Moisture Sensitivity Level 1
- Built-in bias resistors enable the configuration of an inverter circuit without connecting external input resistors
- Surface mount package ideally Suited for Automatic Insertion
- NPN

### Mechanical Data

- **Package:** SOT-323
- **Terminals:** Tin plated leads, solderable per J-STD-002 and JESD22-B102
- **Marking:** E21

### ■Equivalent circuit

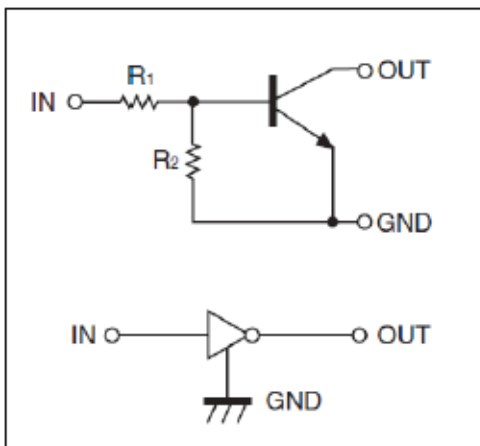

### ■Maximum Ratings (Ta=25°C Unless otherwise specified)

ITEM	SYMBOL	UNIT	CONDITIONS	VALUE
Supply Voltage	$V_{CC}$	V		50
Input Voltage	$V_{IN}$	V		-5 to +10
Collector Current	$I_C$	mA		100
Power Dissipation	$P_D$	mW		200
Junction Temperature	$T_j$	°C		150
Storage Temperature	$T_{stg}$	°C		-55 to +150



# DTC113ZUA

## ■ Electrical Characteristics (Ta=25°C unless otherwise specified)

ITEM	SYMBOL	UNIT	CONDITIONS	MIN	TYP	MAX
Input voltage	$V_{I(off)}$	V	VCC=5V, I <sub>o</sub> =100uA	0.3		
	$V_{I(on)}$	V	V <sub>o</sub> =0.3V, I <sub>o</sub> =20mA			3
Output voltage	$V_{O(on)}$	V	I <sub>o</sub> / I <sub>i</sub> = 10mA/0.5 mA			0.3
Input current	I <sub>I</sub>	mA	V <sub>I</sub> =5V			7.2
Output current	I <sub>O(off)</sub>	uA	VCC=50V, V <sub>i</sub> =0			0.5
DC current gain	G <sub>I</sub>		V <sub>o</sub> =5V, I <sub>o</sub> =5mA	33		
Input resistance	R <sub>1</sub>	kΩ		0.7	1	1.3
Resistance ratio	R <sub>2</sub> /R <sub>1</sub>			8	10	12
Transition frequency	f <sub>T</sub>	MHz	V <sub>o</sub> =10V, I <sub>o</sub> =5mA, f=100MHz		250	

## ■ Ordering Information (Example)

PREFERRED P/N	PACKING CODE	UNIT WEIGHT(g)	MINIMUM PACKAGE(pcs)	INNER BOX QUANTITY(pcs)	OUTER CARTON QUANTITY(pcs)	DELIVERY MODE
DTC113ZUA	F2	Approximate 0.005	3000	30000	120000	7" reel

## ■ Characteristics (Typical)

Fig. 1 - DC Current Gain Characteristics

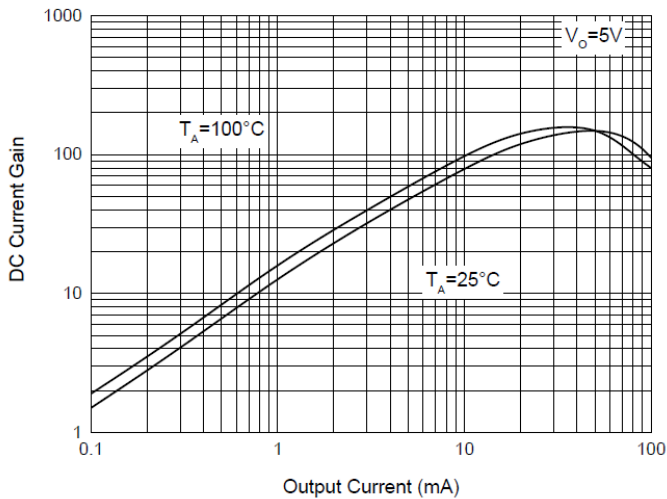

Fig. 2 - Input Voltage (on) Characteristics

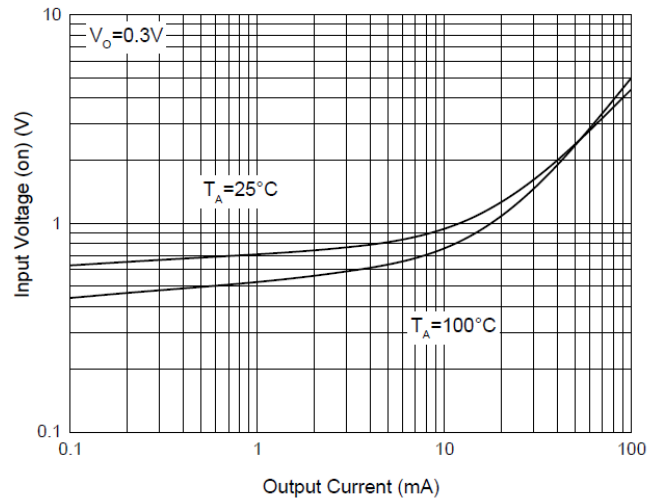



Fig. 3 - Input Voltage (off) Characteristics

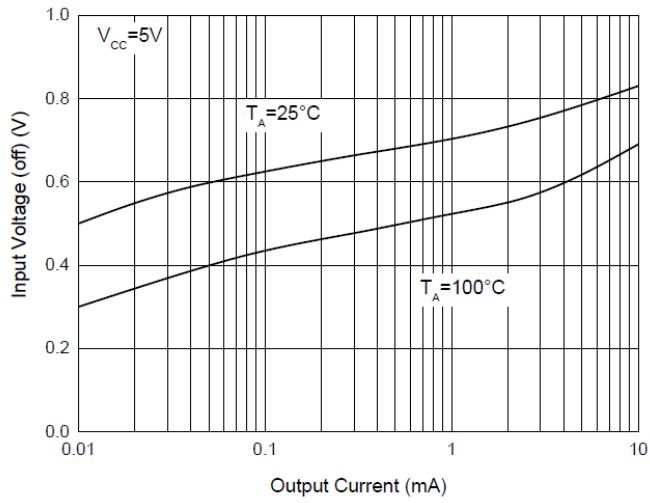

Fig. 4 - Output Voltage Characteristics

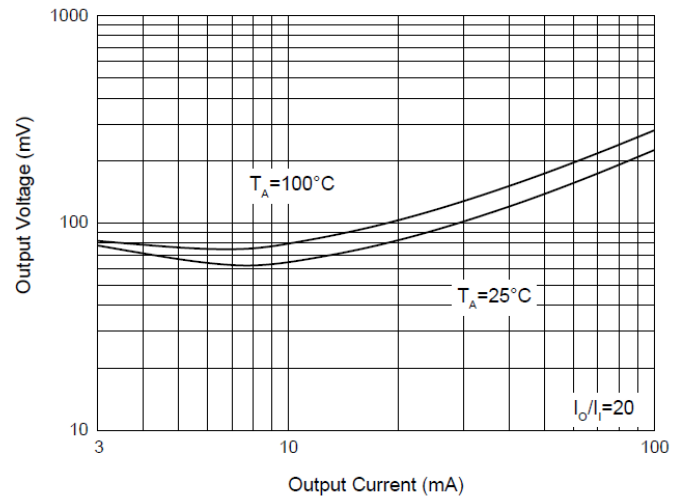
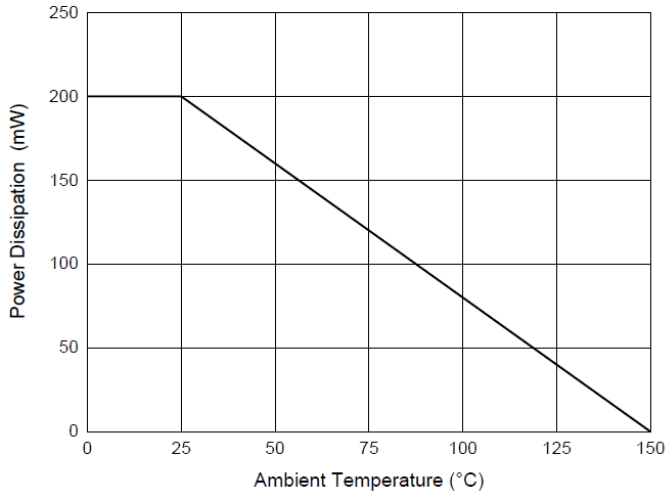

Fig. 5 - Power Derating Curve





# DTC113ZUA

## ■SOT-323 Package Outline Dimensions

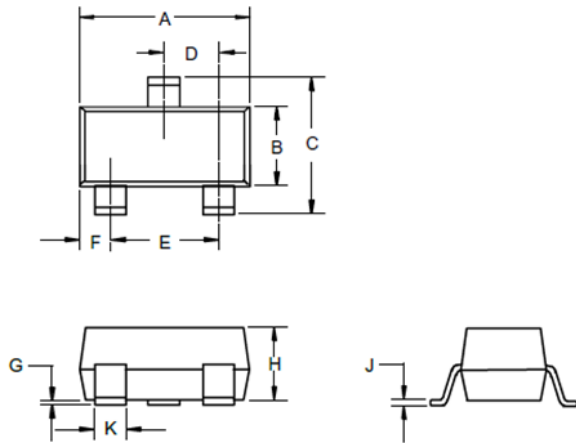

DIM	INCHES		MM		NOTE
	MIN	MAX	MIN	MAX	
A	0.071	0.087	1.80	2.20	
B	0.045	0.053	1.15	1.35	
C	0.083	0.096	2.10	2.45	
D	0.026Nominal		0.65Nominal		
E	0.047	0.055	1.20	1.40	
F	0.012	0.016	0.30	0.40	
G	0.000	0.004	0.00	0.10	
H	0.035	0.039	0.90	1.00	
J	0.004	0.010	0.10	0.250	
K	0.006	0.016	0.15	0.40	

## ■SOT-323 Soldering Footprint

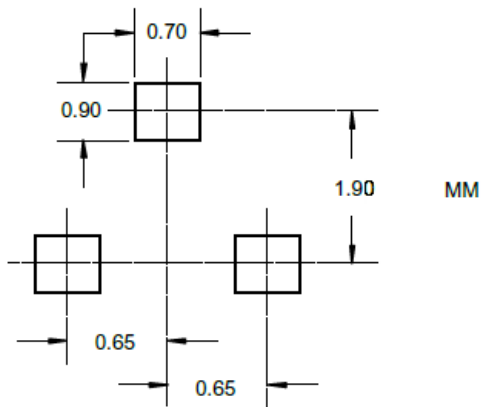



## Disclaimer

The information presented in this document is for reference only. Yangzhou Yangjie Electronic Technology Co., Ltd. reserves the right to make changes without notice for the specification of the products displayed herein to improve reliability, function or design or otherwise.

The product listed herein is designed to be used with ordinary electronic equipment or devices, and not designed to be used with equipment or devices which require high level of reliability and the malfunction of which would directly endanger human life (such as medical instruments, transportation equipment, aerospace machinery, nuclear-reactor controllers, fuel controllers and other safety devices), Yangjie or anyone on its behalf, assumes no responsibility or liability for any damages resulting from such improper use of sale.

This publication supersedes & replaces all information previously supplied. For additional information, please visit our website [http:// www.21yangjie.com](http://www.21yangjie.com) , or consult your nearest Yangjie's sales office for further assistance.