

Dual NPN+PNP Small Signal Transistor

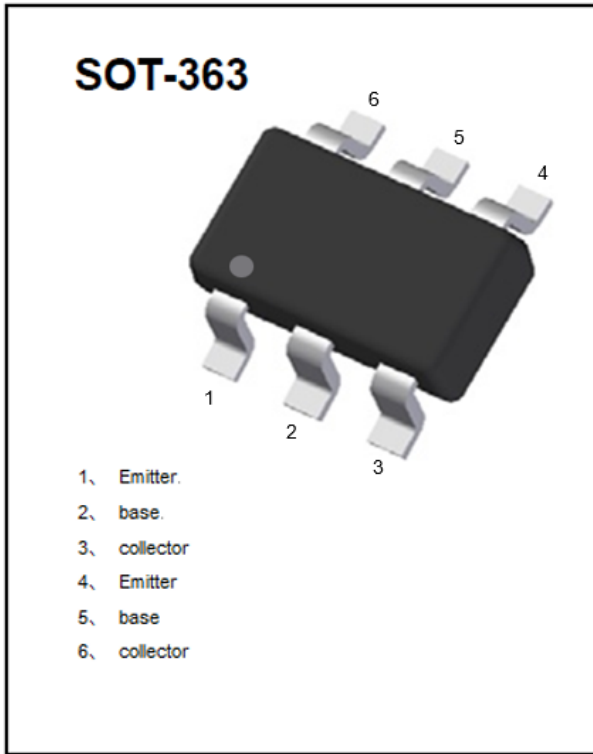

Features

- Epoxy meets UL-94 V-0 flammability rating
- Surface mount package ideally Suited for Automatic Insertion
- NPN/PNP

Mechanical Data

- **Package:** SOT-363
- **Terminals:** Tin plated leads, solderable per J-STD-002 and JESD22-B102
- **Marking:** Z1

Equivalent circuit

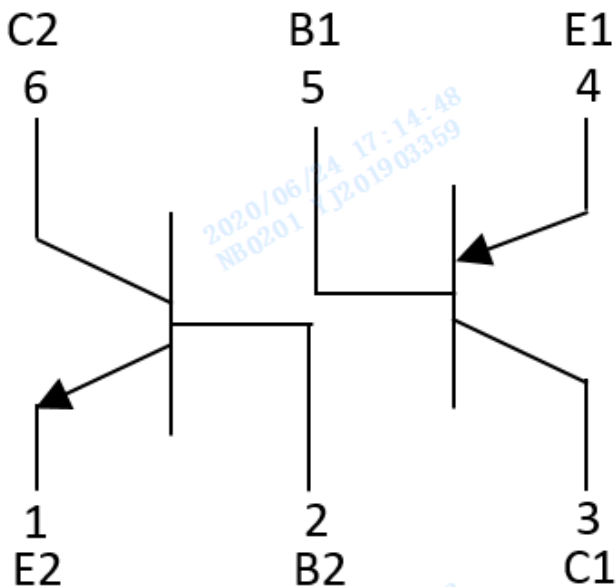



UMZ1N

■ Ordering Information (Example)

PREFERRED P/N	PACKING CODE	UNIT WEIGHT(g)	MINIMUM PACKAGE(pcs)	INNER BOX QUANTITY(pcs)	OUTER CARTON QUANTITY(pcs)	DELIVERY MODE
UMZ1N	F2	Approximate 0.009g	3000	30000	120000	7" reel

■TR1 NPN Pin1、2、6 Maximum Ratings (Ta=25°C Unless otherwise specified)

Item	Symbol	Unit	Conditions	Value
Collector-Base Voltage	VCBO	V	IC=50μA,IE=0	60
Collector-Emitter Voltage	VCEO	V	IC =1mA,IB=0	50
Emitter-Base Voltage	VEBO	V	IE=50μA,IC=0	7
Collector Current -Continuous	IC	mA		150
Total Device Dissipation	PC	mW		200
Junction Temperature	Tj	°C		150
Storage Temperature	TSTG	°C		-55 to +150

■TR1 NPN Pin1、2、6 Electrical Characteristics (Ta=25°C unless otherwise specified)

Item	Symbol	Unit	Conditions	Min	TYP	Max
Collector-base breakdown voltage	VCBO	V	IC=50μA,IE=0	60		
Collector-emitter breakdown voltage	VCEO	V	IC =1mA,IB=0	50		
Emitter-base breakdown voltage	VEBO	V	IE=50μA,IC=0	7		
Collector cut-off current	ICBO	nA	VCB=60V,IB=0			100
Collector cut-off current	IEBO	nA	VEB=7V, IC=0			100
DC current gain	hFE		VCE=6V,IC=1mA	120		560
Collector-emitter saturation voltage	VCE(sat)	V	IC=50mA,IB=5mA			0.4
Transition frequency	fT	MHz	VCE=12V,IC=-2mA,f=100MHz		180	
Output capacitance	Cob	pF	VCB=12V,IE=0A,f=1MHz			3.5



UMZ1N

■TR2 PNP Pin3、4、5 Maximum Ratings (Ta=25°C Unless otherwise specified)

Item	Symbol	Unit	Conditions	Value
Collector-Base Voltage	VCBO	V	IC=-50μA,IE=0	-60
Collector-Emitter Voltage	VCEO	V	IC=-1mA,IB=0	-50
Emitter-Base Voltage	VEBO	V	IE=-50μA,IC=0	-6
Collector Current	IC	mA		-150
Total Device Dissipation	PC	mW		200
Junction Temperature	Tj	°C		150
Storage Temperature	TSTG	°C		-55 to +150

■TR2 PNP Pin3、4、5 Electrical Characteristics (Ta=25°C unless otherwise specified)

Item	Symbol	Unit	Conditions	Min	TYP	Max
Collector-base breakdown voltage	V _{(BR)CBO}	V	IC=-50μA,IE=0	-60		
Collector-emitter breakdown voltage	V _{(BR)CEO}	V	IC=-1mA,IB=0	-50		
Emitter-base breakdown voltage	V _{(BR)EBO}	V	IE=-50μA,IC=0	-6		
Collector-Base cut-off current	I _{CBO}	nA	VCB=-60V,IB=0			-100
Emitter-Base cut-off current	I _{EBO}	nA	VEB=-6V,IC=0			-100
DC current gain	h _{FE}		VCE=-6V,IC=-1mA	120		560
Collector-emitter saturation voltage	V _{CE(sat)}	V	IC=-50mA,IB=-5mA			-0.5
Transition frequency	Ft	MHz	VCE=-12V,IE=2mA,f=100MHz		140	
Output capacitance	Cob	pF	VCB=-12V,IE=0A,f=1MHz			5



■ TR1 NPN Pin1、2、6 Characteristics (Typical)

Static Characteristic

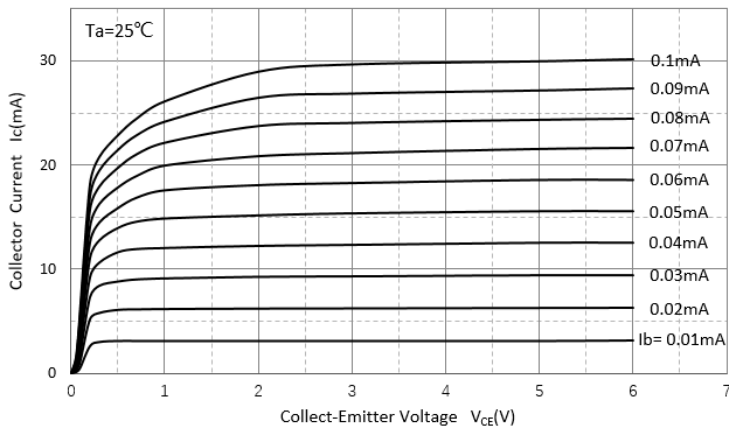

DC Current Gain

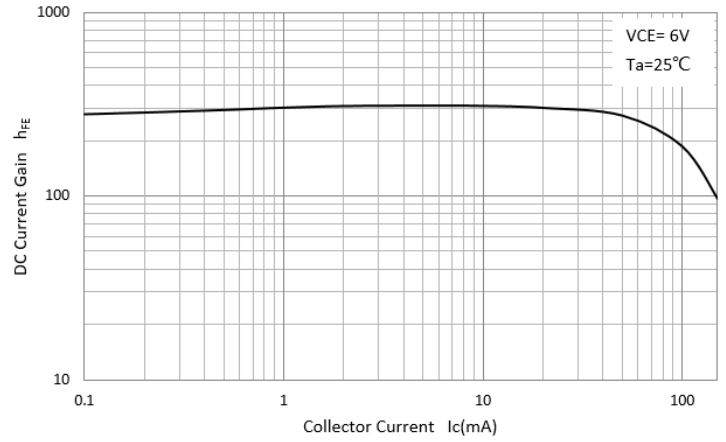

Collector-Emitter Saturation Voltage

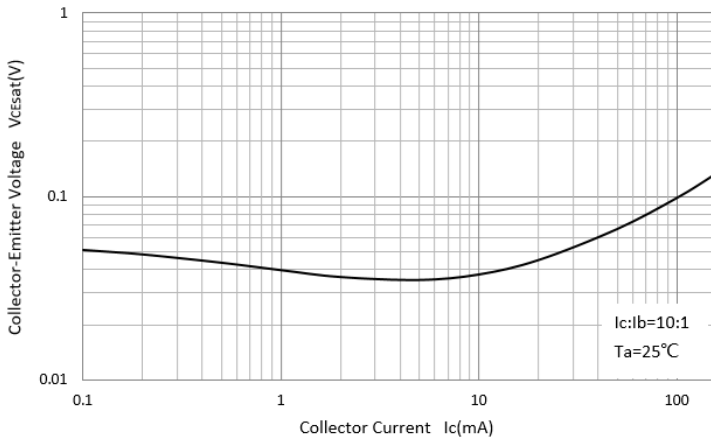

Base-Emitter Saturation Voltage

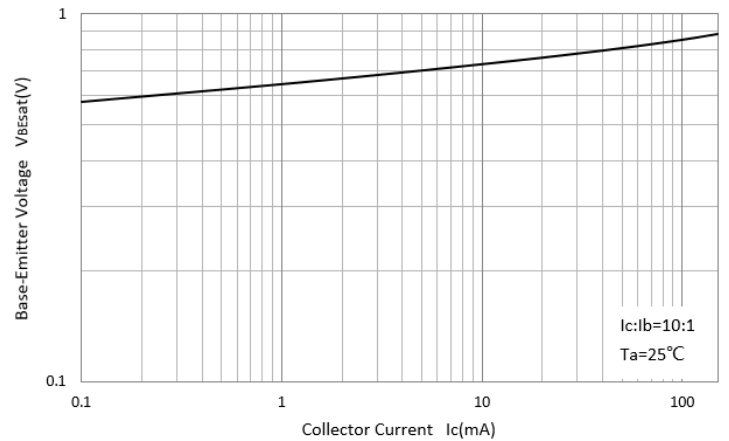

Base-Emitter On Voltage

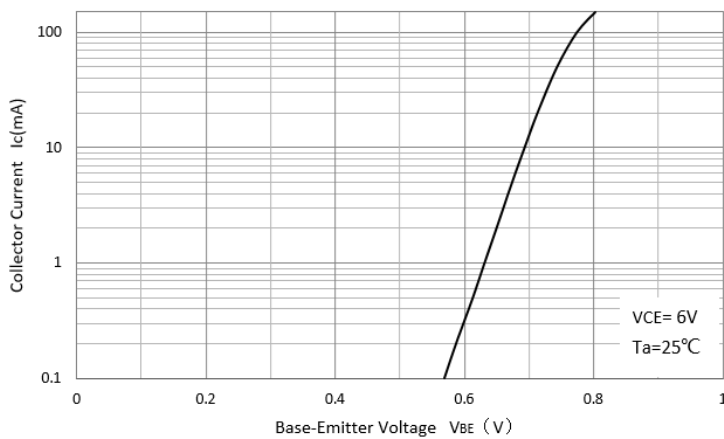

Cob/Cib-V_{CB}/V_{EB}

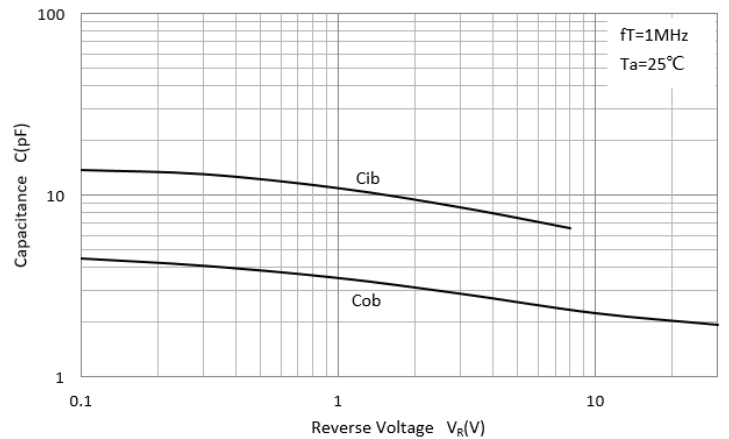



■ TR2 PNP Pin3、4、5 Characteristics (Typical)

Fig. 1 - Static Characteristics

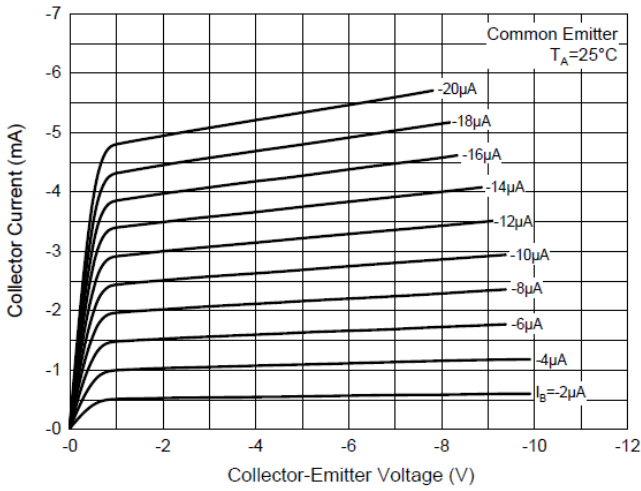

Fig. 2 - DC Current Gain Characteristics

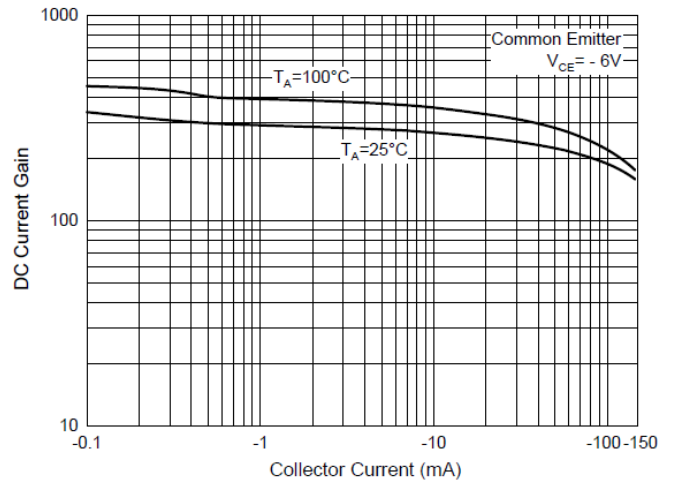

Fig. 3 - Base-Emitter Saturation Voltage Characteristics

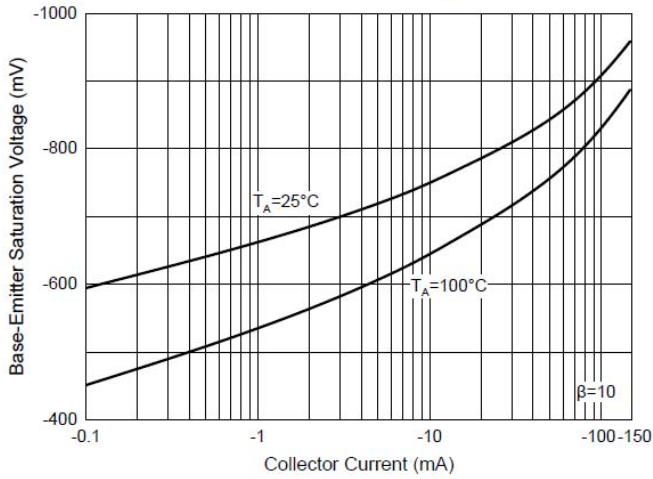

Fig. 4 - Collector-Emitter Saturation Voltage Characteristics

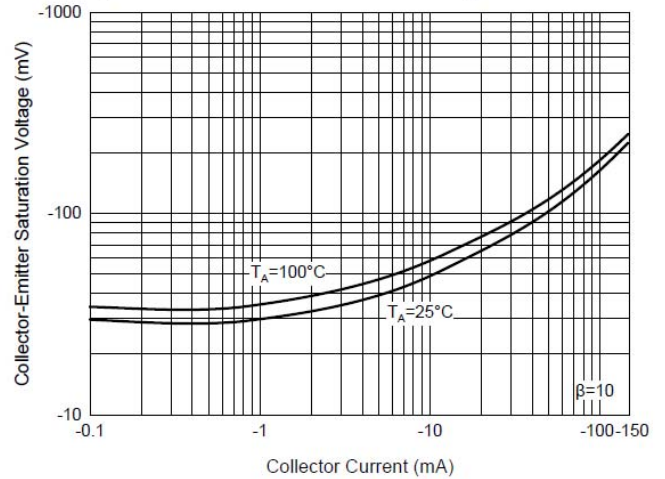
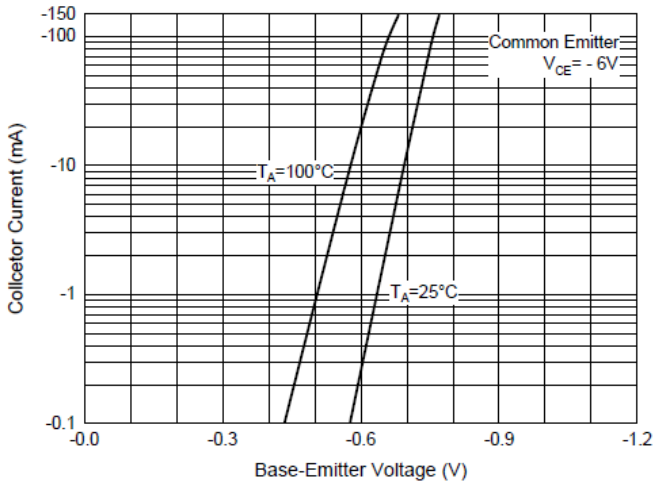

Fig. 11 - Base-Emitter Voltage Characteristics





UMZ1N

■SOT-363 Package Outline Dimensions

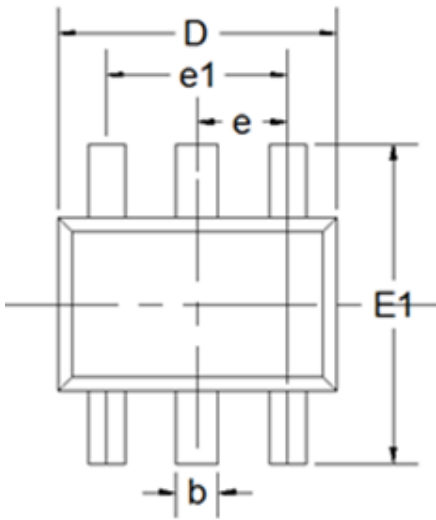

DIM	DIMENSIONS			
	INCHES		MM	
	MIN	MAX	MIN	MAX
A	0.035	0.043	0.9	1.1
A1	0	0.004	0	0.1
A2	0.035	0.039	0.9	1
b	0.006	0.014	0.15	0.35
c	0.002	0.01	0.05	0.25
D	0.071	0.087	1.8	2.2
E	0.045	0.053	1.15	1.35
E1	0.085	0.096	2.15	2.45
e	0.026Typ		0.65Typ	
e1	0.047	0.055	1.2	1.4
L	0.021Typ		0.525Typ	
L1	0.01	0.018	0.26	0.46
φ	0°	8°	0°	8°

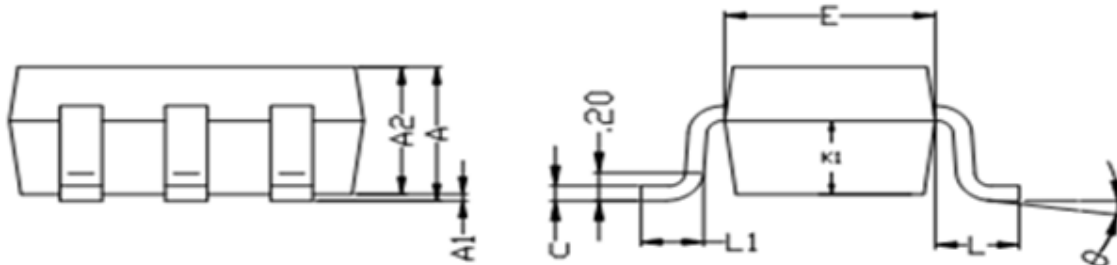

■SOT-363 Soldering Footprint

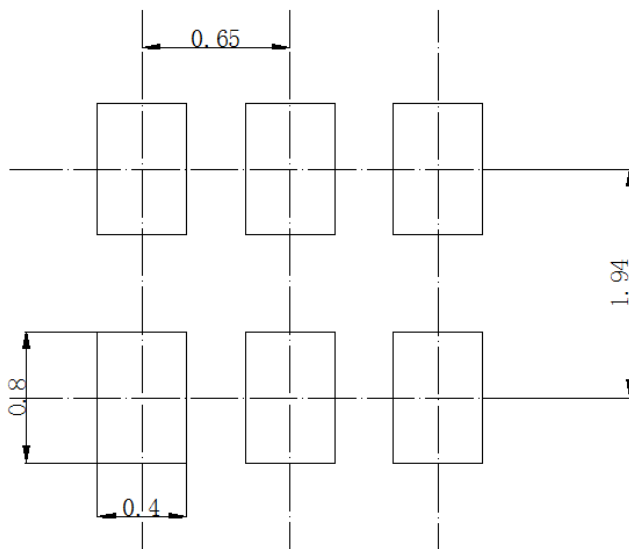

Unit: mm



UMZ1N

Disclaimer

The information presented in this document is for reference only. Yangzhou Yangjie Electronic Technology Co., Ltd. reserves the right to make changes without notice for the specification of the products displayed herein to improve reliability, function or design or otherwise.

The product listed herein is designed to be used with ordinary electronic equipment or devices, and not designed to be used with equipment or devices which require high level of reliability and the malfunction of which would directly endanger human life (such as medical instruments, transportation equipment, aerospace machinery, nuclear-reactor controllers, fuel controllers and other safety devices), Yangjie or anyone on its behalf, assumes no responsibility or liability for any damages resulting from such improper use of sale.

This publication supersedes & replaces all information previously supplied. For additional information, please visit our website [http:// www.21yangjie.com](http://www.21yangjie.com) , or consult your nearest Yangjie's sales office for further assistance.