

## IGBT Discrete

$V_{CE}$	<b>1200</b>	<b>V</b>
$I_C$	<b>40</b>	<b>A</b>
$V_{CE(SAT)} I_C=40A$	<b>1.70</b>	<b>V</b>

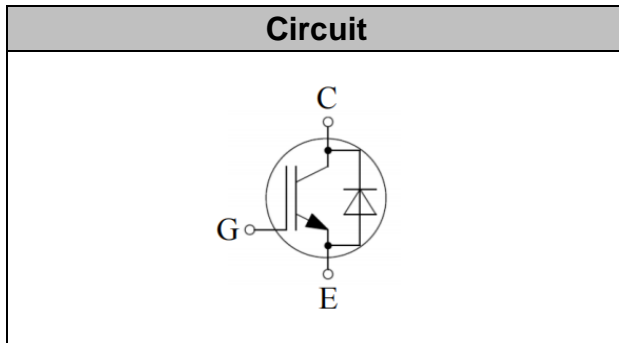

### Applications

- Inverter for motor drive
- AC and DC servo drive amplifier
- Uninterruptible power supply

### Features

- High breakdown voltage to 1200V for improved reliability
- Maximum junction temperature 175°C
- Positive temperature coefficient
- Including fast & soft recovery anti-parallel FWD
- High short circuit capability(10us)

## Maximum Ratings

Parameter	Symbol	Value	Unit
Collector-Emitter Breakdown Voltage	$V_{CE}$	1200	V
DC Collector Current, limited by $T_{jmax}$ $T_C=25^\circ C$ $T_C=100^\circ C$	$I_C$	80 40	A
Diode Forward Current, limited by $T_{jmax}$ $T_C=25^\circ C$ $T_C=100^\circ C$	$I_F$	80 40	A
Continuous Gate-Emitter Voltage	$V_{GE}$	$\pm 20$	V
Transient Gate-Emitter Voltage ( $t_p \leq 10\mu s, D < 0.010$ )	$V_{GE}$	$\pm 30$	V
Turn off Safe Operating Area $V_{CE} \leq 1200V$ , $T_j \leq 150^\circ C$		160	A
Pulsed Collector Current, $V_{GE}=15V$ , $t_p$ limited by $T_{jmax}$	$I_{CM}$	160	A
Diode Pulsed Current, $t_p$ limited by $T_{jmax}$	$I_{Fpuls}$	160	A
Short Circuit Withstand Time, $V_{GE}=15V, V_{CC}=600V, V_{CEM} \leq 1200V$	$T_{sc}$	10	$\mu s$
Power Dissipation, $T_j=175^\circ C, T_C=25^\circ C$	$P_{tot}$	375	W



Operating Junction Temperature	$T_j$	-40...+175	°C
Storage Temperature	$T_s$	-55...+150	°C
Soldering Temperature, wave soldering 1.6mm (0.063in.) from case for 10s		260	°C

**Electrical Characteristics of the IGBT** ( $T_j = 25^\circ\text{C}$  unless otherwise specified):

Parameter	Symbol	Conditions	Min.	Typ.	Max.	Unit
<b>Static</b>						
Collector-Emitter Breakdown Voltage	$BV_{CES}$	$V_{GE}=0V, I_C=250\mu A$	1200		-	V
Gate Threshold Voltage	$V_{GE(th)}$	$V_{GE}=V_{CE}, I_C=1.4mA$	5.2	5.8	6.5	V
Collector-Emitter Saturation Voltage	$V_{CE(sat)}$	$V_{GE}=15V, I_C=40A$ $T_j=25^\circ\text{C}$ , $T_j=125^\circ\text{C}$ $T_j=150^\circ\text{C}$		1.70 1.95 2.05	2.00	V
Zero Gate Voltage Collector Current	$I_{CES}$	$V_{CE}=1200V, V_{GE}=0V$ $T_j=25^\circ\text{C}$ , $T_j=150^\circ\text{C}$			0.25 4	mA
Gate-Emitter Leakage Current	$I_{GES}$	$V_{CE}=0V, V_{GE}=\pm 20V$			100	nA

Parameter	Symbol	Conditions	Min.	Typ.	Max.	Unit
<b>Dynamic</b>						
Input Capacitance	$C_{ies}$	$V_{CE}=25V, V_{GE}=0V,$ $f=1MHz$	-	5.47	-	nF
Reverse Transfer Capacitance	$C_{res}$		-	0.05	-	
Gate Charge	$Q_G$	$V_{CC}=600V, I_C=40A,$ $V_{GE}=15V$	-	0.26	-	uC

**Electrical Characteristics of the Diode** ( $T_j = 25^\circ\text{C}$  unless otherwise specified):

Parameter	Symbol	Conditions	Min.	Typ.	Max.	Unit
<b>Static</b>						
Diode Forward Voltage	$V_F$	$I_F = 40\text{A}$ $T_j = 25^\circ\text{C}$ , $T_j = 125^\circ\text{C}$ $T_j = 150^\circ\text{C}$		2.00 1.80 1.70	2.50	V

**Switching Characteristic, Inductive Load**

Parameter	Symbol	Conditions	Min.	Typ.	Max.	Unit
<b>Dynamic , at <math>T_j = 25^\circ\text{C}</math></b>						
Turn-on Delay Time	$t_{d(on)}$	$V_{CC} = 600\text{V}$ , $I_C = 40\text{A}$ , $V_{GE} = -5\text{V} \sim 15\text{V}$ , $R_g = 20\Omega$	-	23	-	ns
Rise Time	$t_r$		-	75	-	ns
Turn-on Energy	$E_{on}$		-	4.2	-	mJ
Turn-off Delay Time	$t_{d(off)}$		-	267	-	ns
Fall Time	$t_f$		-	175	-	ns
Turn-off Energy	$E_{off}$		-	2.1	-	mJ
<b>Dynamic , at <math>T_j = 125^\circ\text{C}</math></b>						
Turn-on Delay Time	$t_{d(on)}$	$V_{CC} = 600\text{V}$ , $I_C = 40\text{A}$ , $V_{GE} = -5\text{V} \sim 15\text{V}$ , $R_g = 20\Omega$	-	25	-	ns
Rise Time	$t_r$		-	73	-	ns
Turn-on Energy	$E_{on}$		-	4.3	-	mJ
Turn-off Delay Time	$t_{d(off)}$		-	298	-	ns
Fall Time	$t_f$		-	262	-	ns
Turn-off Energy	$E_{off}$		-	3.5	-	mJ
<b>Dynamic , at <math>T_j = 150^\circ\text{C}</math></b>						
Turn-on Delay Time	$t_{d(on)}$	$V_{CC} = 600\text{V}$ , $I_C = 40\text{A}$ , $V_{GE} = -5\text{V} \sim 15\text{V}$ , $R_g = 20\Omega$	-	26	-	ns
Rise Time	$t_r$		-	69	-	ns
Turn-on Energy	$E_{on}$		-	4.4	-	mJ
Turn-off Delay Time	$t_{d(off)}$		-	321	-	ns
Fall Time	$t_f$		-	315	-	ns
Turn-off Energy	$E_{off}$		-	3.9	-	mJ



## Electrical Characteristics of the DIODE

Parameter	Symbol	Conditions	Min.	Typ.	Max.	Unit
<b>Dynamic , at T<sub>j</sub>= 25°C</b>						
Reverse Recovery Current	I <sub>rr</sub>	I <sub>F</sub> =40A, V <sub>R</sub> =600V, di/dt= -520A/μs,	-	16	-	A
Diode reverse recovery time	t <sub>rr</sub>		-	524	-	ns
Reverse Recovery Charge	Q <sub>rr</sub>		-	3.23	-	uC
Reverse Recovery Energy	E <sub>rec</sub>		-	1.2	-	mJ
<b>Dynamic , at T<sub>j</sub>= 125°C</b>						
Reverse Recovery Current	I <sub>rr</sub>	I <sub>F</sub> =40A, V <sub>R</sub> =600V di/dt= -520A/μs,	-	19	-	A
Diode reverse recovery time	t <sub>rr</sub>		-	825	-	ns
Reverse Recovery Charge	Q <sub>rr</sub>		-	7.41	-	uC
Reverse Recovery Energy	E <sub>rec</sub>		-	2.9	-	mJ
<b>Dynamic , at T<sub>j</sub>= 150°C</b>						
Reverse Recovery Current	I <sub>rr</sub>	I <sub>F</sub> =40A, V <sub>R</sub> =600V di/dt= -520A/μs,	-	23	-	A
Diode reverse recovery time	t <sub>rr</sub>		-	938	-	ns
Reverse Recovery Charge	Q <sub>rr</sub>		-	8.95	-	uC
Reverse Recovery Energy	E <sub>rec</sub>		-	3.6	-	mJ

## Thermal Resistance

Parameter	Symbol	Max. Value	Unit
IGBT Thermal Resistance, Junction - Case	R <sub>θ(j-c)</sub>	0.40	K/W
Diode Thermal Resistance, Junction - Case	R <sub>θ(j-c)</sub>	0.65	K/W
Thermal Resistance, Junction - Ambient	R <sub>θ(j-a)</sub>	40	K/W

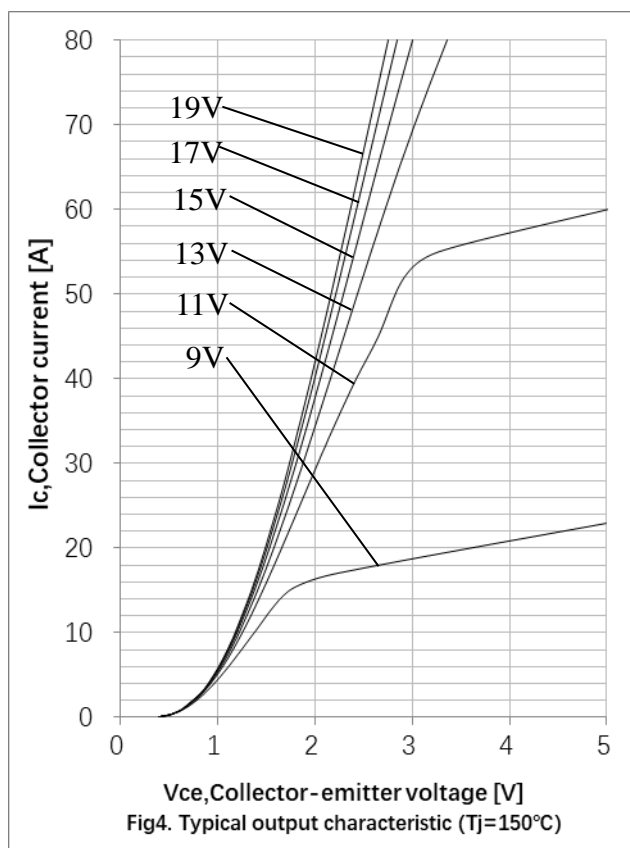
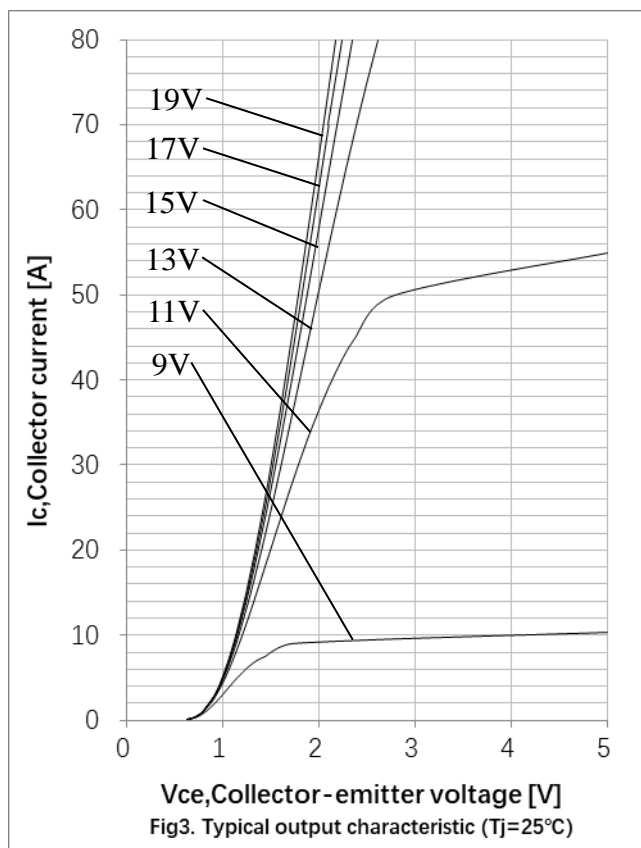
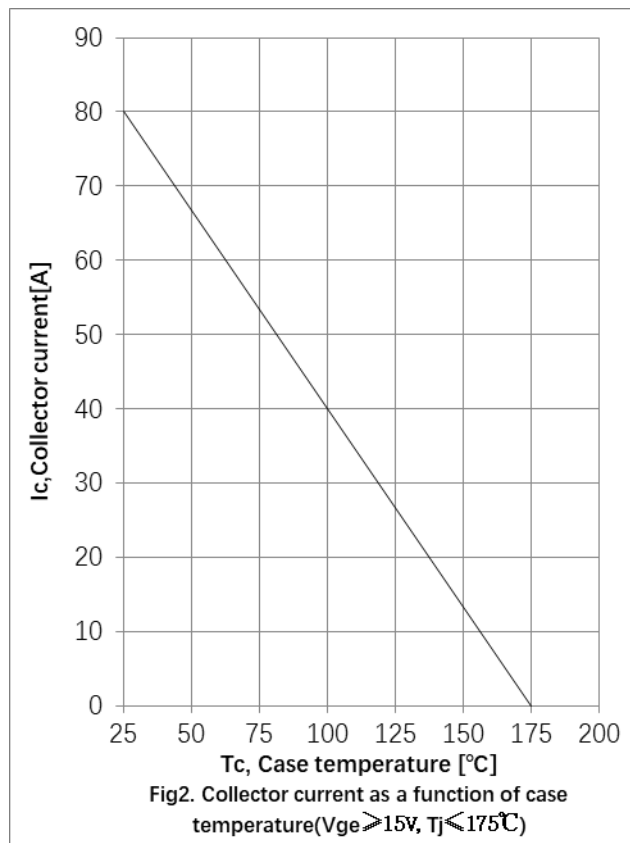
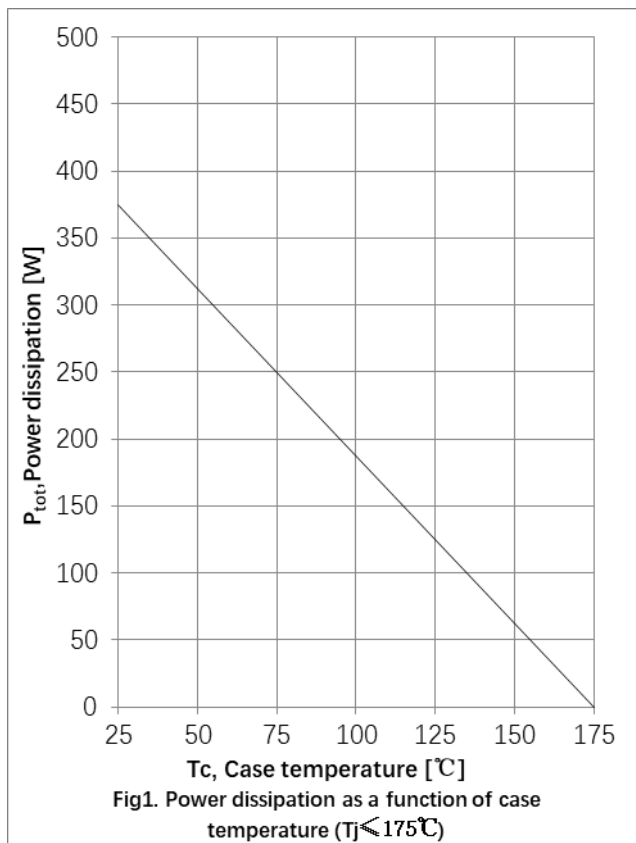

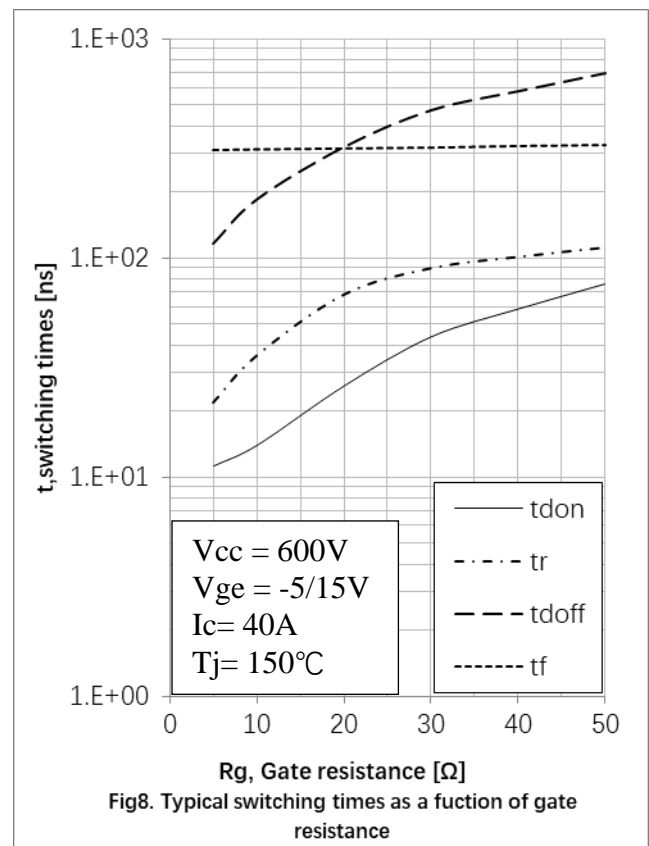
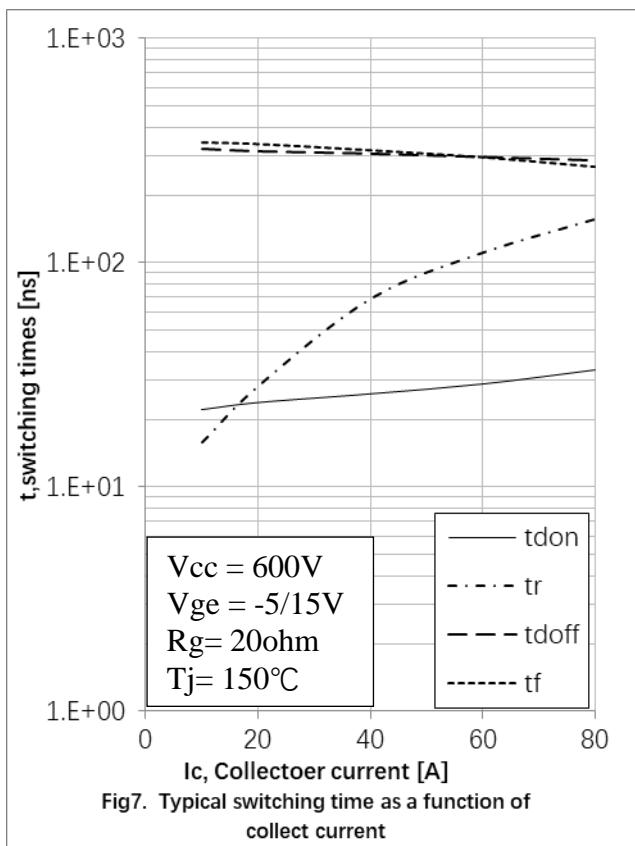
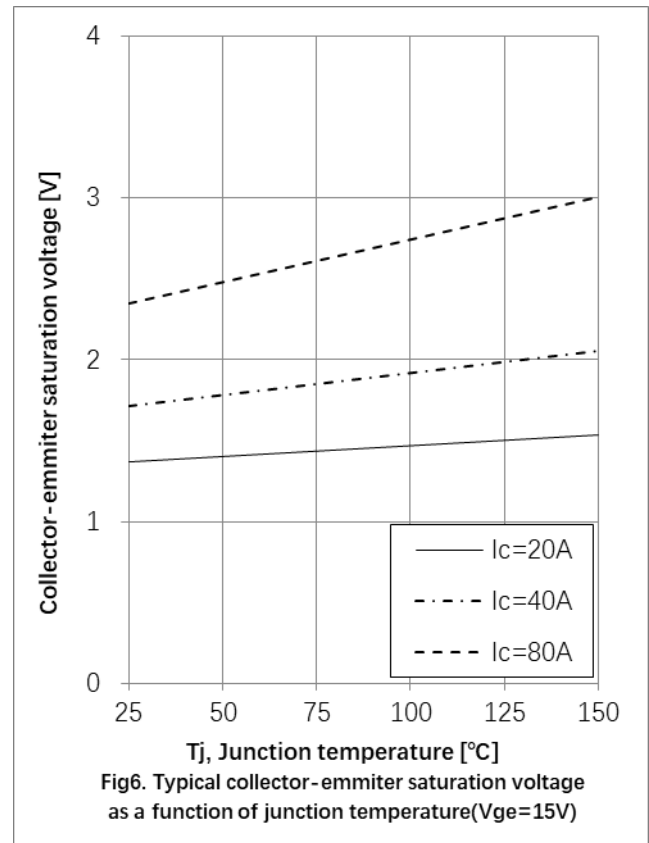
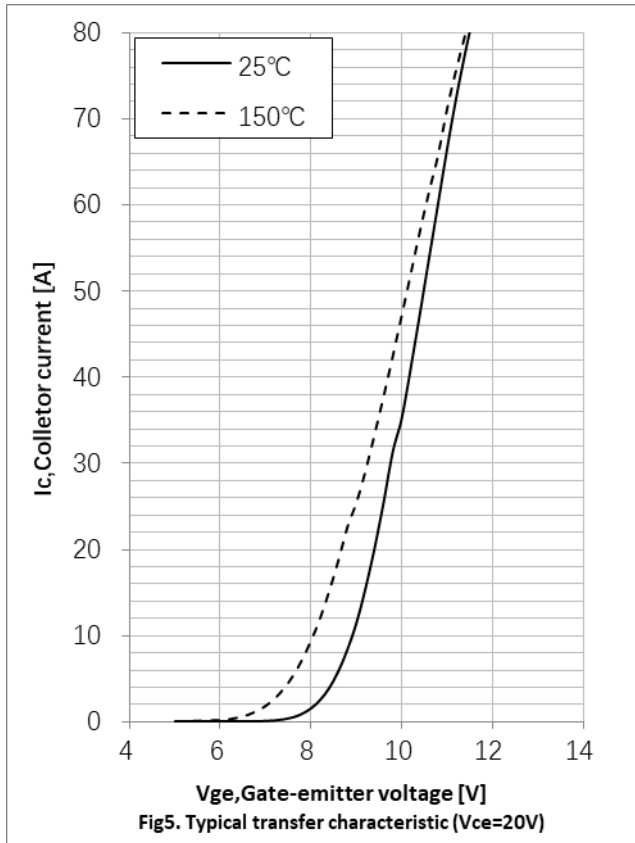

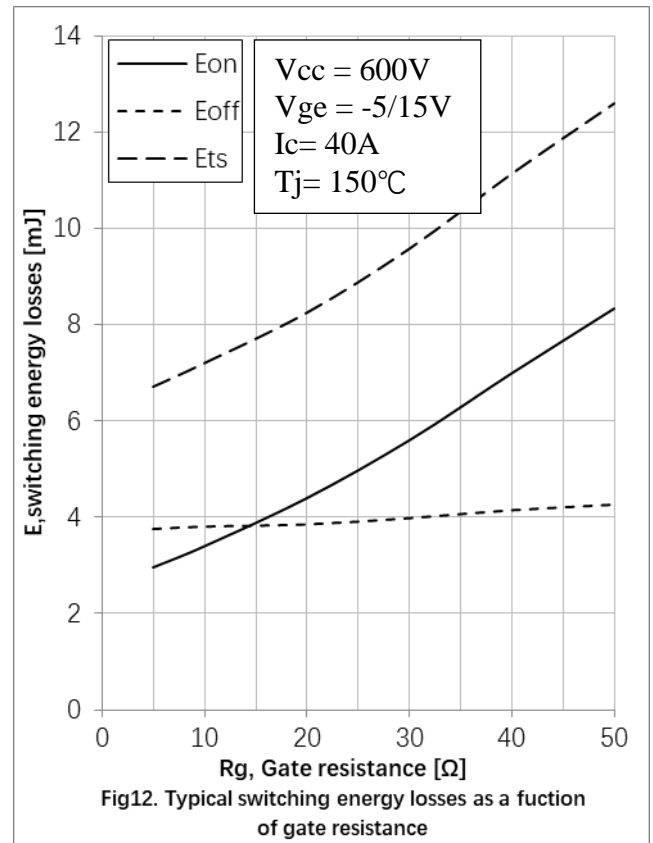
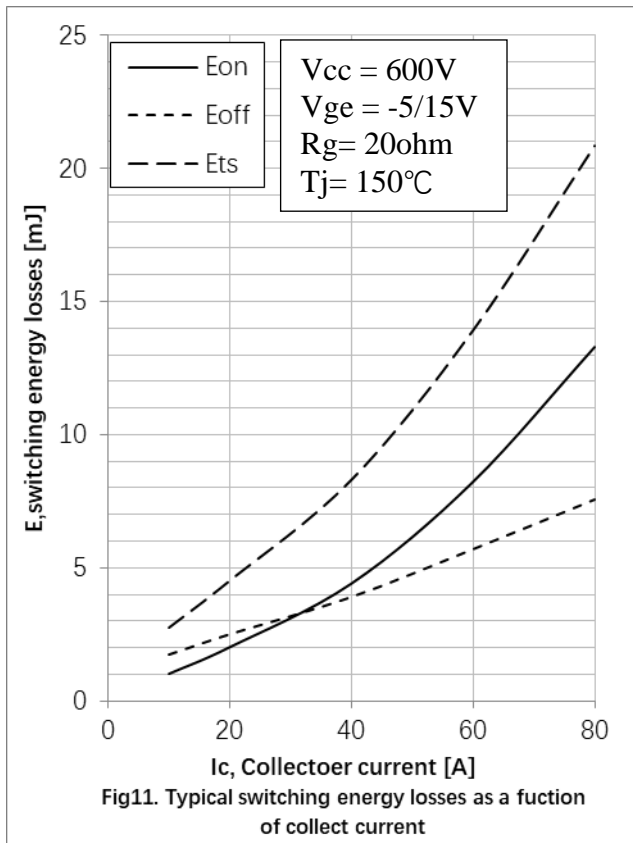
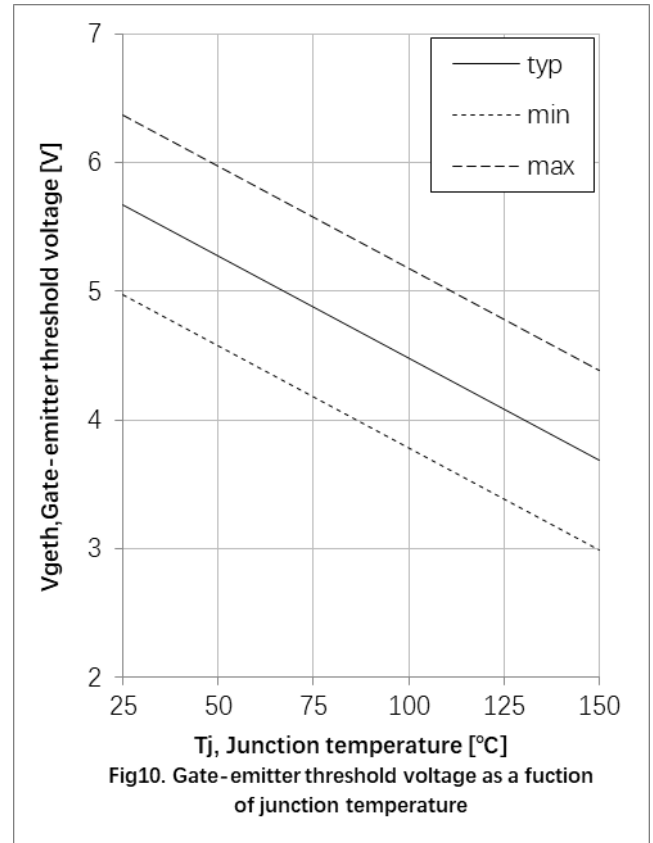
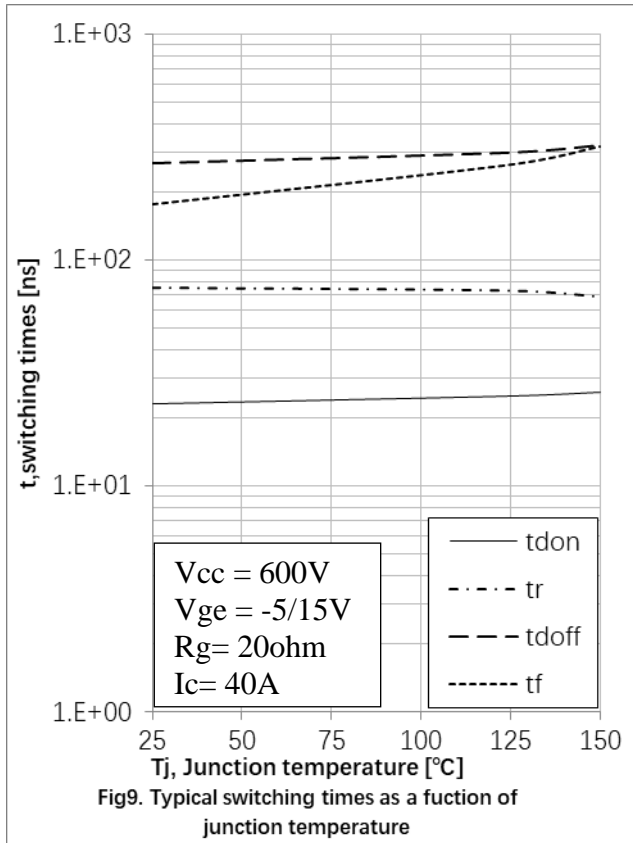

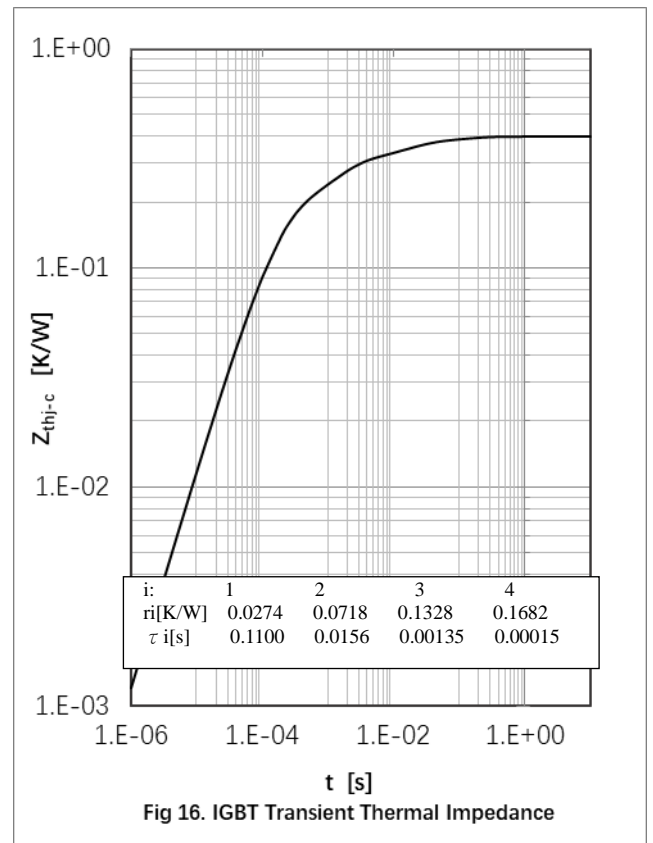
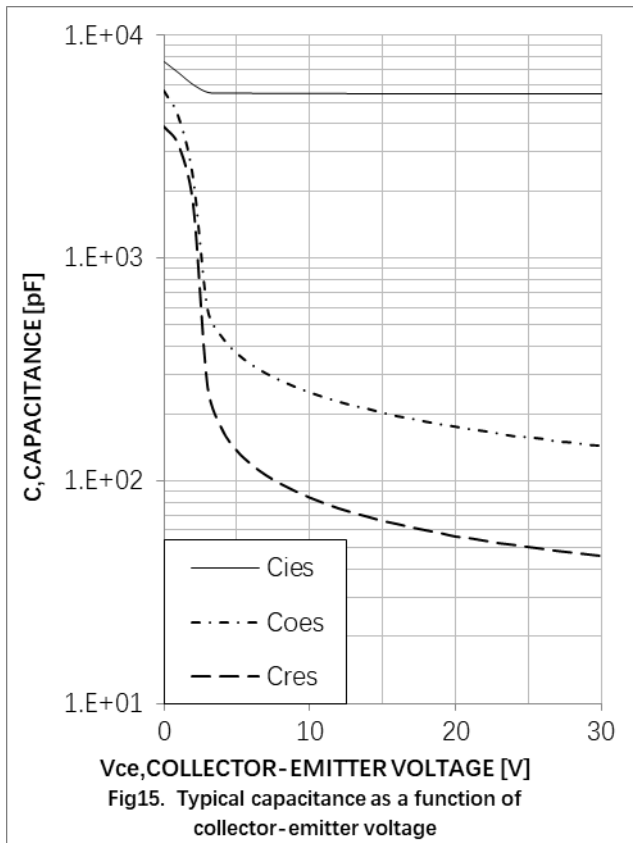
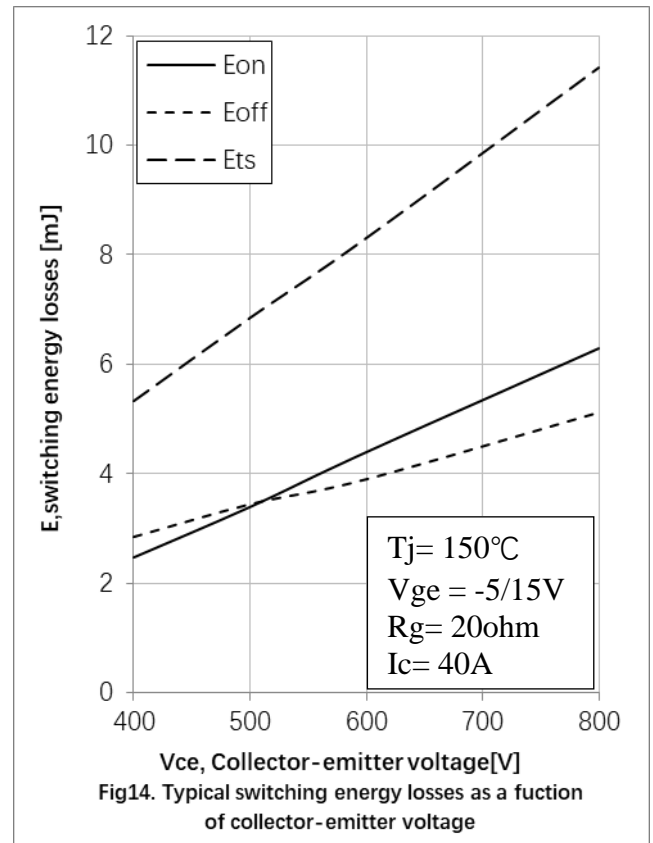
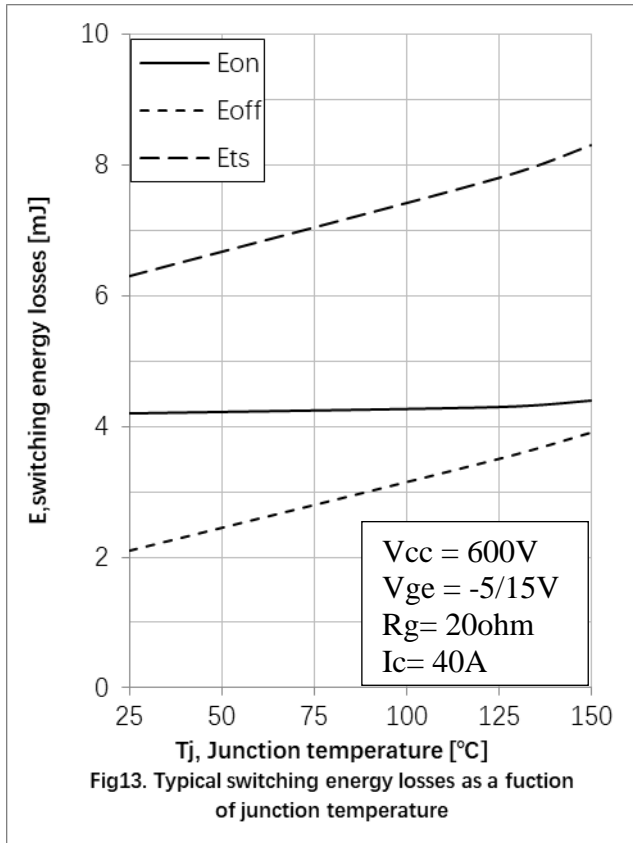



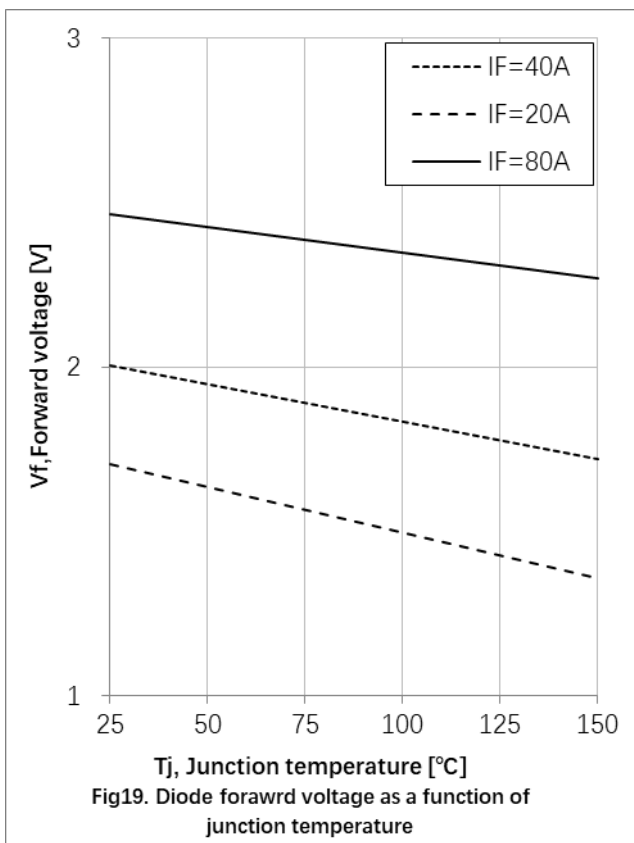
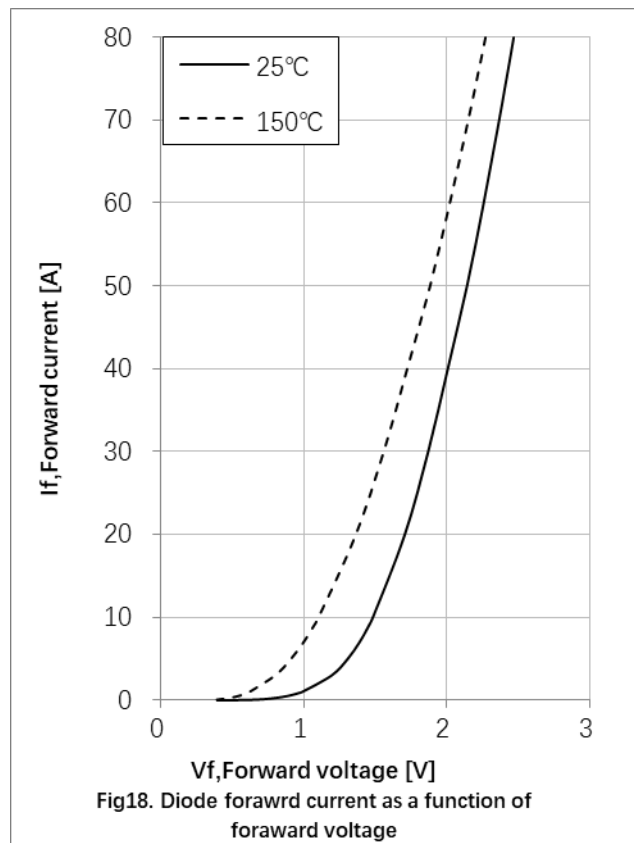
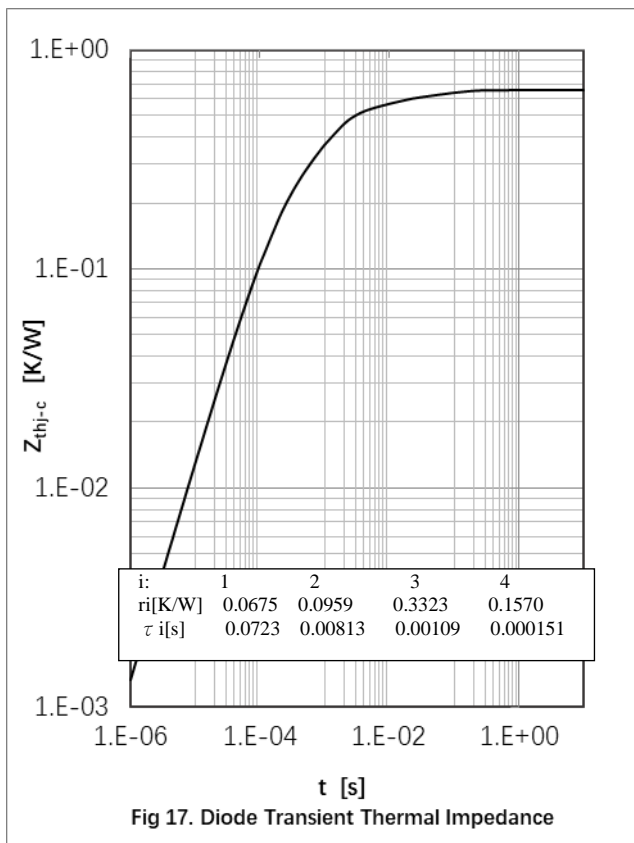

● **Circuit Diagram**

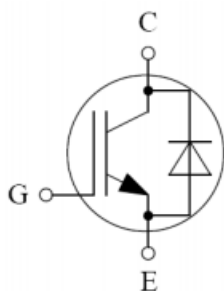

● **Package Outline Information**

CASE: TO 247

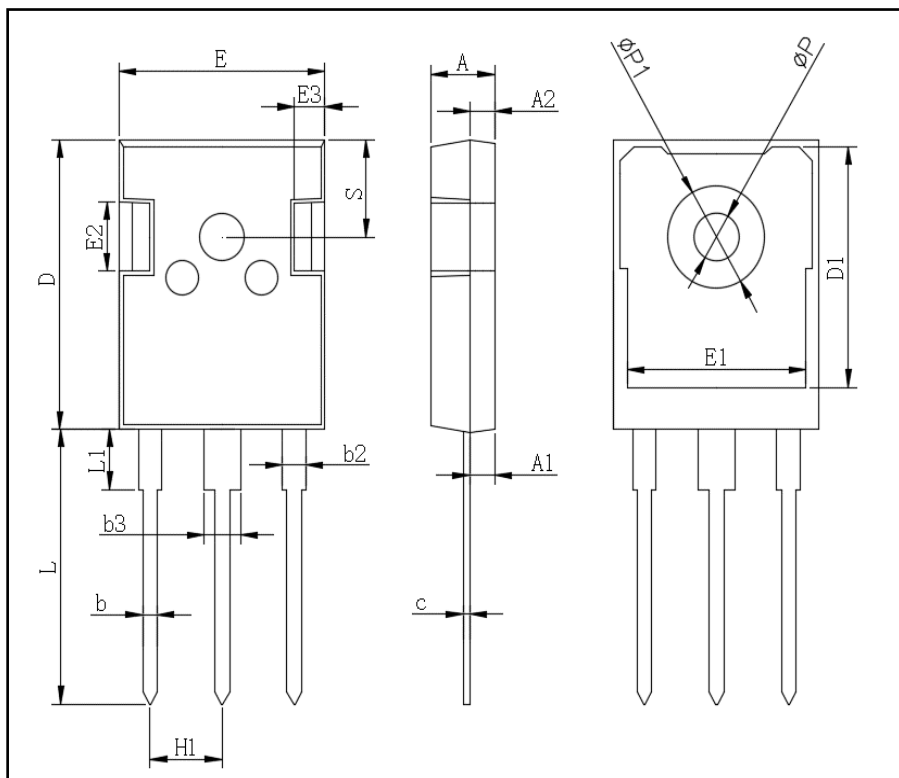

TO-247AB		
Dim	Min	Max
A	4.80	5.20
A1	2.21	2.61
A2	1.85	2.15
b	1.0	1.4
b2	1.91	2.21
C	0.5	0.7
D	20.70	21.30
D1	16.25	16.85
E	15.50	16.10
E1	13.0	13.6
E2	4.80	5.20
E3	2.30	2.70
L	19.62	20.22
L1	-	4.30
$\Phi P$	3.40	3.80
$\Phi P1$	-	7.30
S	6.15TYP	
H1	5.44TYP	
b3	2.80	3.20